

VR CONNECTOR

Disconnectable Insulation displacement connectors

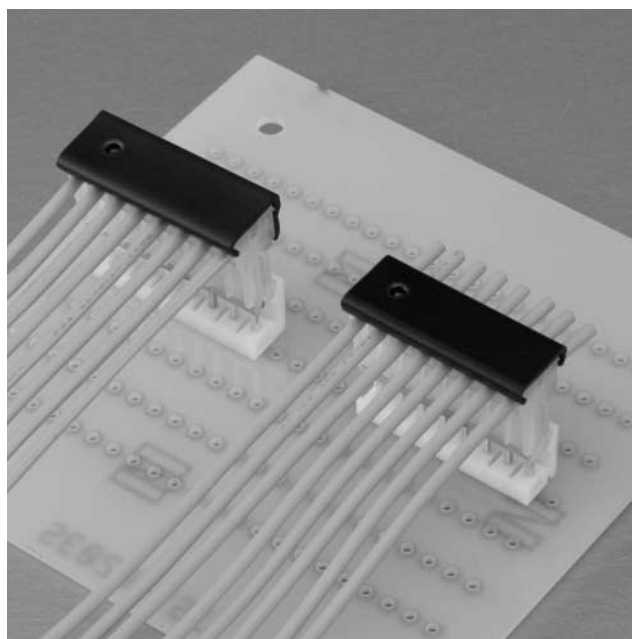

This 3.96mm pitch insulation displacement connector is used with printed circuit boards. Since the connector can accommodate 18 AWG wires and has a large pitch, it is ideal for connecting power supply circuits.

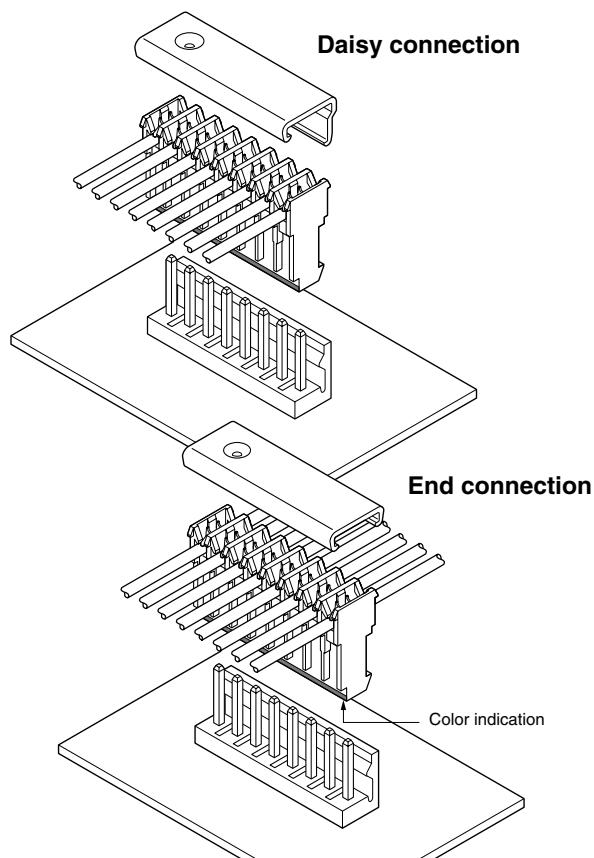

Features

• Twin U-slot insulation displacement section

The insulation displacement section connected to each wire consists of two tin-plated slots (twin U-slots), which ensures reliable connection.

• Two types of connections

This receptacle can be used for both daisy chain (through) connections and end connections. The end connections can be made from either direction.

Specifications

- Current rating: 7 A AC, DC (AWG #18)
 - Voltage rating: 250 V AC, DC
 - Temperature range: -25°C to +85°C
(including temperature rise in applying electrical current)
 - Contact resistance: Initial value/ 10 mΩ max.
After environmental tests/ 20 mΩ max.
 - Insulation resistance: 1,000 MΩ min.
 - Withstanding voltage: 1,500 VAC/minute
 - Applicable wire: UL1007(Contact JST for details regarding other UL wires.)
AWG #26, #24, #22, #20, #18
Conductor construction/
AWG #26 to #22: 7 strands, tin-coated
AWG #20: 7 and 26 strands, tin-coated
AWG #18: 34 and 43 strands
Insulation O.D./1.3 to 2.1 mm
 - Applicable PC board thickness: 0.8 to 1.6 mm
- * Temperature Range:
The aforementioned temperature range of this connector is described in JST Standard Product Specification.
- * Refer to "General Instruction and Notice when using Terminals and Connectors" at the end of this catalog.
- * Contact JST for details.
- * Compliant with RoHS.

Note:

Do not branch in parallel current which exceeds the rated current. If branched in parallel, current imbalance or other problems may develop. If it is absolutely necessary to branch a large current in parallel, design the circuits without causing imbalance and provide an extra margin for each circuit.

Standards

Recognized E60389

Certified LR20812

Cover

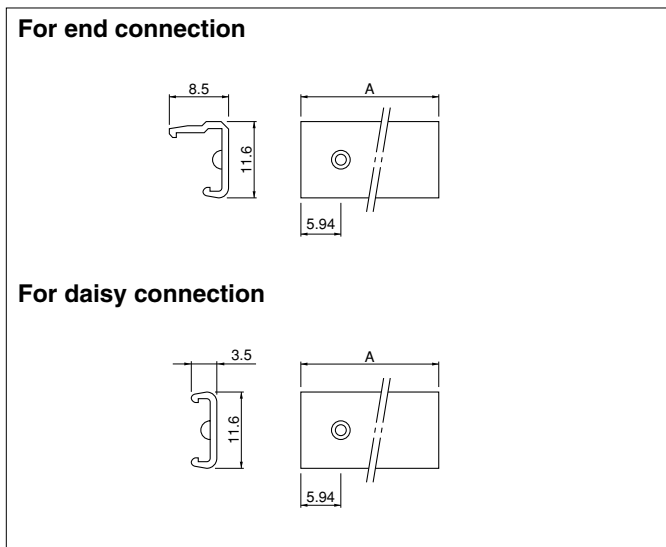

Cir- cuits	Model No.		Dimensions A (mm)	Q'ty / box
	For end connection	For daisy connection		
2	VRC-02E	VRC-02D	7.92	1,000
3	VRC-03E	VRC-03D	11.88	1,000
4	VRC-04E	VRC-04D	15.84	500
5	VRC-05E	VRC-05D	19.80	500
6	VRC-06E	VRC-06D	23.76	500
8	VRC-08E	VRC-08D	31.68	250
12	—	VRC-12D	47.52	200

Material

Polyvinyl chloride, UL94V-0 (black)

RoHS compliance

Note:

1. The use of this cover keeps the terminated part from dust.
2. Contact JST if cover is required.

Receptacle

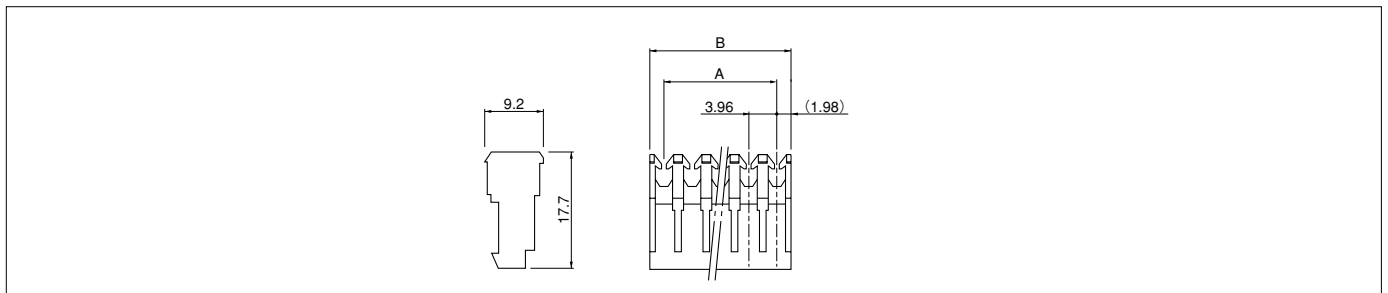

Cir- cuits	Model No.					Dimensions (mm)		Q'ty / bag
	AWG #26 (natural/white)	AWG #24 (black)	AWG #22 (red)	AWG #20 (brown)	AWG #18 (orange)	A	B	
2	02VR-6S	02VR-4K	02VR-2R	02VR-AN	02VR-BO	3.96	7.92	2,000
3	03VR-6S	03VR-4K	03VR-2R	03VR-AN	03VR-BO	7.92	11.88	1,000
4	04VR-6S	04VR-4K	04VR-2R	04VR-AN	04VR-BO	11.88	15.84	1,000
5	05VR-6S	05VR-4K	05VR-2R	05VR-AN	05VR-BO	15.84	19.80	1,000
6	06VR-6S	06VR-4K	06VR-2R	06VR-AN	06VR-BO	19.80	23.76	1,000
8	08VR-6S	08VR-4K	08VR-2R	08VR-AN	08VR-BO	27.72	31.68	500
9	09VR-6S	09VR-4K	09VR-2R	09VR-AN	09VR-BO	31.68	35.64	500
10	10VR-6S	10VR-4K	10VR-2R	10VR-AN	10VR-BO	35.64	39.60	500
12	12VR-6S	12VR-4K	12VR-2R	12VR-AN	12VR-BO	43.56	47.52	250
15	15VR-6S	15VR-4K	15VR-2R	15VR-AN	15VR-BO	55.44	59.40	250

Material and Finish

Contact: Brass, Copper-undercoated, tin-plated (reflow treatment)
Housing: PA 66, UL94V-2

RoHS compliance This product displays (LF)(SN) on a label.

Note:

1. In addition to mating with the VR headers, the VR receptacle will also mate with VH and VS headers.
2. Color indication is shown by a line on each receptacle.

<For reference> As the color identification, the following alphabet shall be put in the underlined part. For availability, delivery and minimum order quantity, contact JST.

ex. **02VR-6S**

standard color AWG#26: S...natural (white), AWG#24: K...black, AWG#22: R...red, AWG#20: N...brown, AWG#18: O...orange, TR...tomato red E...blue M...green

VR CONNECTOR

Locking header (Friction lock header)

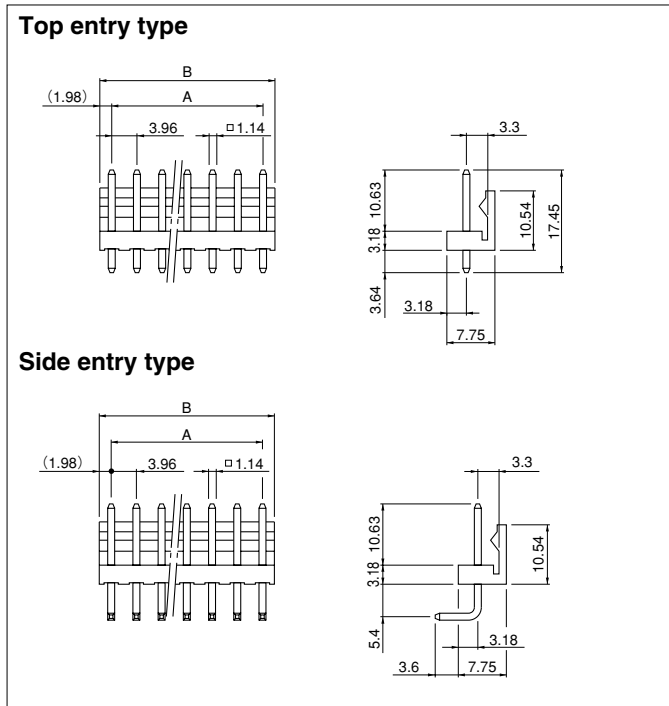

Circuits	Model No.		Dimensions (mm)		Q'ty / box	
	Top entry type	Side entry type	A	B	Top entry type	Side entry type
2	B 2P-VR	B 2PS-VR	3.96	7.92	1,000	250
3	B 3P-VR	B 3PS-VR	7.92	11.88	500	250
4	B 4P-VR	B 4PS-VR	11.88	15.84	250	250
5	B 5P-VR	B 5PS-VR	15.84	19.80	250	250
6	B 6P-VR	B 6PS-VR	19.80	23.76	250	100
8	B 8P-VR	B 8PS-VR	27.72	31.68	200	100
9	B 9P-VR	B 9PS-VR	31.68	35.64	100	100
10	B10P-VR	B10PS-VR	35.64	39.60	100	100
12	B12P-VR-P	B12PS-VR-P	43.56	47.52	100	100
15	B15P-VR-P	B15PS-VR-P	55.44	59.40	100	100

Material and Finish

Post: Brass, copper-undercoated, tin-plated (reflow treatment)
 Wafer: 2 to 10 circuits / PA 66, UL94V-0, natural (white)
 12 and 15 circuits / PBT, UL94V-0, natural (white)

RoHS compliance This product displays (LF)(SN) on a label.

Polarizing key

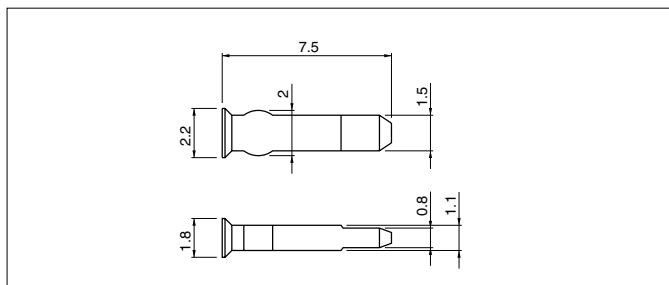

Model No.	Q'ty / bag
PK-VR	5,000

Material

Glass-filled PA 66, UL94V-0, natural (gray)

RoHS compliance
 Note: Not UL/CSA approved.

PC board layout (viewed from soldering side) and Assembly layout

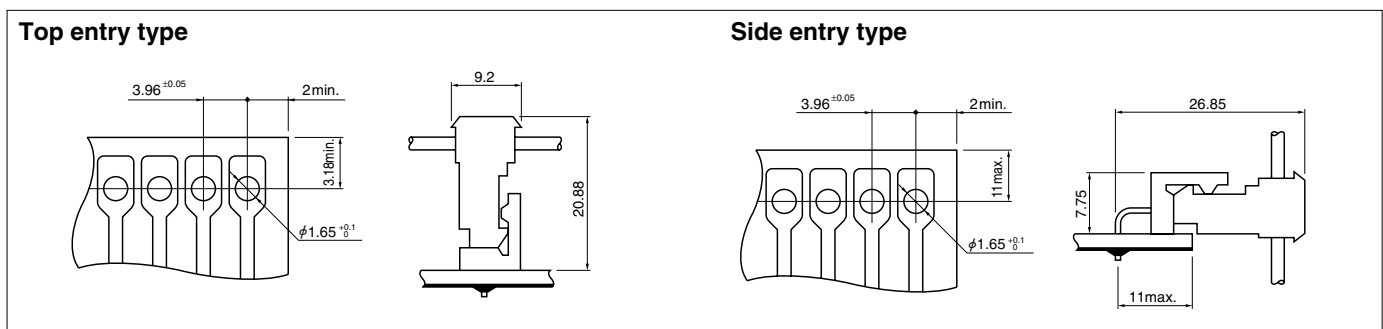

Note:

- Tolerances are non-cumulative: $\pm 0.05\text{mm}$ for all centers.
- Hole dimensions differ according to the type of PC board and piercing method. The dimensions above should serve as a guideline. Contact JST for details.